

Panasonic

ideas for life

Multi-Format Live Switcher AV-HS400

● Specifications

Video processing	Video format	SD (480/59.94i, 576/50i), HD (1080/59.94i, 1080/50i, 720/59.94p, 720/50p)	WIPE/DVE	Pattern	WIPE x 12, Squeeze x 11, SLIDE x 8, 3D DVE x 12 (3 directions) Excluding 3D, selection with key transition is possible independently of background.	
M/E		1M/E		Transition method	FADER, AUTO	
Input	Video processing	Y:Cb:Cr, 4:2:2 10 bit RGB, 4:4:4 8 bit	Transition	Transition type	Cut, mix, wipe (including DVE), background and key can be selected.	
	Video	4 inputs (HD/SD-SDI) Option: A maximum of four inputs (up to 2 boards each of 2 of 3 types of input boards can be added: HD/SD-SDI x 2, HD/SD-analog x 2, DVI/RGB x 2).		KEYER	Key source	BUS
	Key	Assign one out of video inputs	Key fill	BUS, MATTE	Key mode	Linear key, Lum key, Chroma key (Key only)
	DSK	Assign one out of video inputs	PinP	Transition method	AUTO (PinP only)	Transition type
Reference	Black burst/TRI (loop through) x 1		Interface	Serial (EDITOR)	Dsub9pin x 1: RS422A (GVG protocol compatible)	
Output	Video	Standard: Four outputs (PGM x 2, general-purpose x 2, each HD/SD-SDI) Option: A maximum of four outputs (up to 2 boards each of 2 types of output boards can be added: general-purpose x 4, each HD/SD-analog x 2, DVI/analog x 1 each). The six general-purpose output interfaces (OUT1 to 6) above are assignable as PGM, PVW, AUX, multi-screen and keyout.	Removable media	SD memory card slot	1 (for transferring still image files and providing an upgrade capability)	
			Power		AC 220 V to 240 V, 50 Hz/60 Hz	
			Dimensions (W x H x D)			420 mm x 132 mm x 408 mm (excluding protrusions)
	Reference	Loop through x 1 (Genlock), Black burst x 1 (internal synchronization)				
						* Features and specifications in this document are subject to change without notice due to continual improvements.

● Dimensions

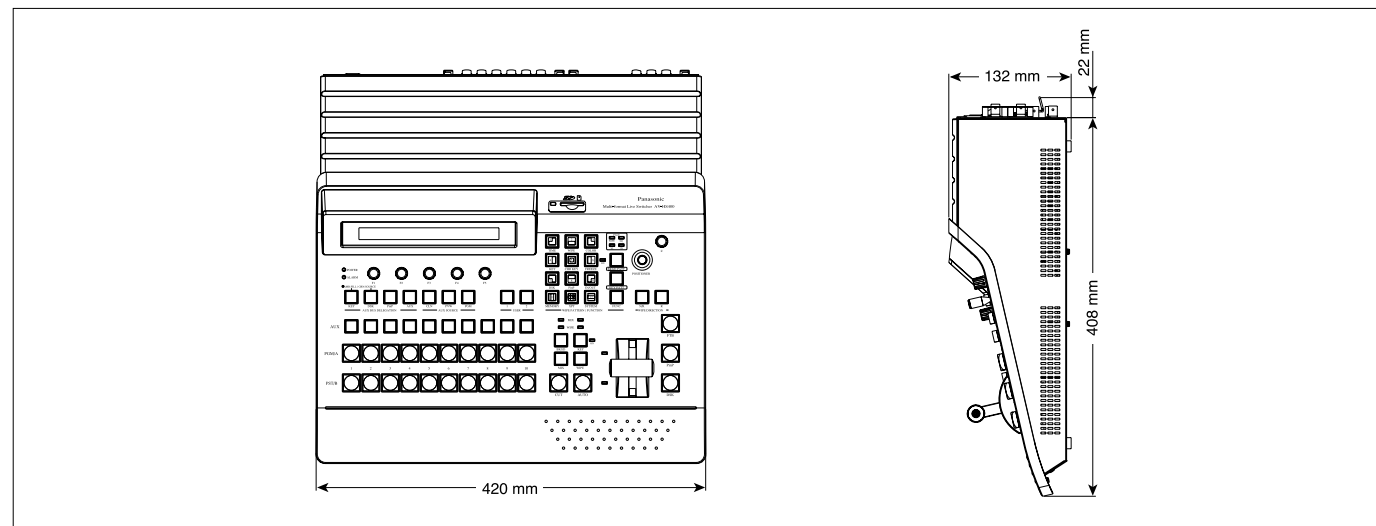

● SD Logo is a trademark.

Panasonic

Matsushita Electric Industrial Co., Ltd.
Panasonic System Solutions Company
Corporate Broadcast and Multimedia Division
4-3-1 Tsunashima-Higashi,
Kohoku-ku, Yokohama City 223-8639, Japan
<http://panasonic.biz/broad/>

[Countries and Regions]

Argentina	+54 1 308 1610	Kuwait	+965 481 2123	Sweden	+46 (8) 680 26 41
Australia	+61 2 9986 7400	Lebanon	+961 1 216827	Switzerland	+41 (0)41 259 96 32
Austria	+43 (0)1 610 80 773	Malaysia	+60 3 5549 5422	Taiwan	+886 2 2725 9100
Bahrain	+973 252292	Mexico	+52 5 488 1000	Thailand	+66 2 731 8888
Belgium	+32 (0)2 481 04 57	Montenegro, Serbia	+41 (0)26 466 25 20	Turkey	+90 216 578 3700
Bulgaria	+359 2 946 0786	Netherlands	+31 73 64 02 577	U.A.E.	+971 4 282201
Brazil	+55 11 3889 4035	New Zealand	+64 9 272 0100	Ukraine	+380 44 4903437
Canada	+1 905 624 5010	Norway	+47 67 91 78 00		+380 44 4903438
China	+86 10 6515 8828	Pakistan	+92 5370320 21		[ext. 112]
(Hong Kong	+852 2313 0888)	Panama	+507 229 2955	U.K.	+44 (0) 1344 70 69 20
Czech Republic	+420 236 032 552/511	Peru	+51 145 29470	U.S.A.	+1 201 348 5300
Denmark	+45 43 20 08 57	Philippines	+63 2 633 6162		+1 800 528 8601
Egypt	+20 2 3938151	Poland	+48 (22)338 1100	Vietnam	+84 88370280
Finland, Latvia, Lithuania, Estonia	+358 (9)521 52 53	Portugal	+351 21 425 77 04		
France	+33 (0)1 49 46 43 59	Puerto Rico	+1 787 750 4300		
Germany	+49 (0)611 235 401	Romania	+40 21 211 4855		
Greece	+30 210 96 92 300	Russia & CIS	+7 495 980 42 06		
Hungary	+36 (1)382 60 60	Saudi Arabia	+966 1 465 0709		
Indonesia	+62 21 385 9449	Singapore	+65 6270 0110		
Iran	+98 21 2271463	Slovak Republic	+421 (0)2 52 92 14 23		
Italy	+39 02 67 88 449	Slovenia, Croatia, Bosnia, Macedonia	+44 (0)20 76 63 36 57		
Jordan	+961 6 586 1914	South Africa	+27 11 313 1400		
Kazakhstan	+7 3272 980 891	Spain	+34 (93) 425 93 00		
Korea	+82 2 2106 6666				



Compact, High-Performance, Multi-Format Live Switcher with Multi-view display

AV-HS400



Full Production Quality from Compact 1M/E Digital Video Switcher

Compatible with HD/SD cameras worldwide.

Sports Arena



HD-SDI Multi-purpose Camera AK-HC1500



P2HD Memory Card Camera-Recorder



P2HD Memory Card Camera-Recorder



P2HD Memory Card Camera-Recorder



P2HD Memory Card Camera-Recorder

News Magazine Show



Worldwide Production



Educational Solution



Hall



Multi-Format HD/SD Compatibility for Worldwide Use

Compatibility with various HD/SD formats will help you meet changing production needs as video moves towards HD on a global scale.

The AV-HS400 lets you up-convert and mix SD signals with HD, to provide an easy transition to full HD production.

The AV-HS400 is compatible with virtually all common input devices.



Compatible formats

HD 1080/59.94i, 1080/50i, 720/59.94p, 720/50p

SD 480/59.94i, 576/50i

* The multi-format logo indicates a model that supports two or more formats including the HD format.

Built-in HD-SDI Interfaces with DVI, Component, and SDI Options for up to 8 Inputs and 8 Outputs

- Four HD-SDI inputs and four HD-SDI outputs* are standard equipment.
- Optional input and output expansion boards include.
 - Input.... Up to four HD/SD-SDI inputs (with AV-HS04M1 x 2) or four HD/SD analog inputs (with AV-HS04M2 x 2) or up to four DVI inputs^{2*} (with AV-HS04M3 x 2) can be added. Optional input boards feature up-converters.
 - Output... Up to four HD/SD analog outputs (with AV-HS04M4 x 2) or up to two DVI outputs^{3*} (with AV-HS04M5 x 2) (scaleable to 1980 x 1080) can be added.
- Input/output features 10-bit video processing and 4:2:2 signal processing.
- Tally outputs for up to eight cameras for extra convenience.
- RS-422 compatible (GVG protocol compatible) control jack.

1* Two interfaces assignable as PGM, PVW, AUX, multi-screen and keyout. 2* Compatible with XGA, SXGA, WXGA.

3* Compatible with XGA (1024 x 768), WXGA (1280 x 768), SXGA (1280 x 1024)^{4*}, WSXGA+ (1680 x 1050)^{4*}, UXGA (1600 x 1200)^{4*}, WUXGA (1920 x 1200)

4* Digital only

Built-in Frame Synchronizers for Versatile Operation

Each input features a built-in 10-bit Frame Synchronizer for smooth switching, even with asynchronous sources, such as DVDs or satellite feeds.

Reference (black burst) signal outputs are provided to enable synchronization with external systems.

The main unit and control panel are integrated in a compact body, ideal for small studios and mobile production.

* AC 220 V to 240 V power supply.

• The unit is not waterproof so please avoid direct contact with rain and water.

Versatile Support for Remote Production

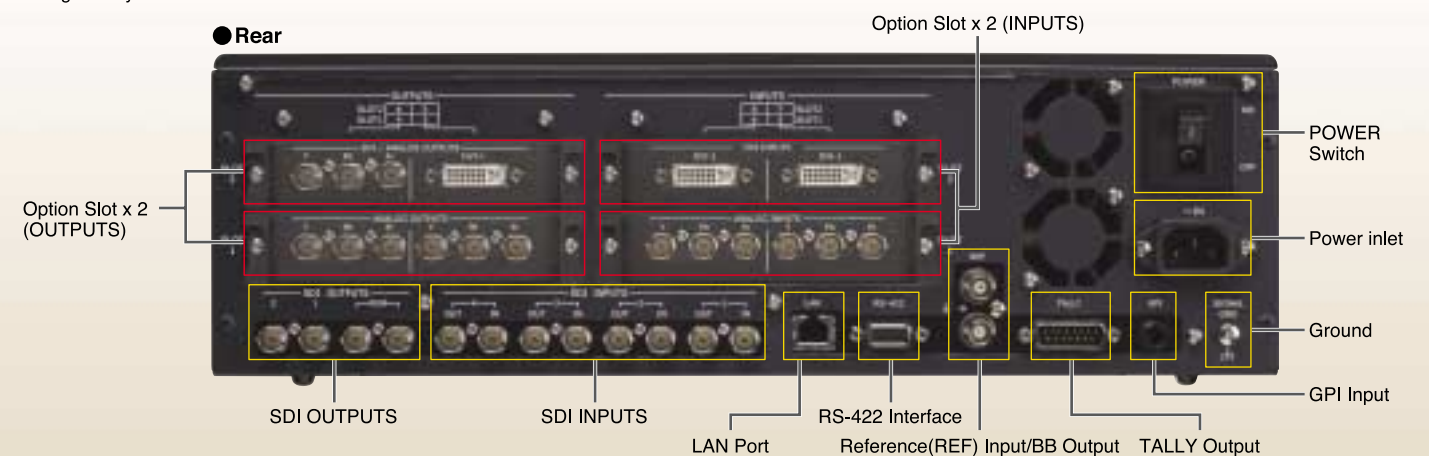

Optional boards enable expansion of inputs/outputs (up to two of each).

The photograph above is an image with the AV-HS04M3 (top right)/AV-HS04M2 (bottom right)/ AV-HS04M5 (top left)/ AV-HS04M4 (bottom left) added.

Multi-system compatibility for extra flexibility in the field and studio. “Compact” -- with all the functions you need for superb results.



■ The main unit and control panel are integrated in a compact body.

■ Multi-view display Preview on a Single Monitor

Multi-view display lets you view PGM, PVW, and inputs (up to 10) on a single screen, reducing the number of monitors required.

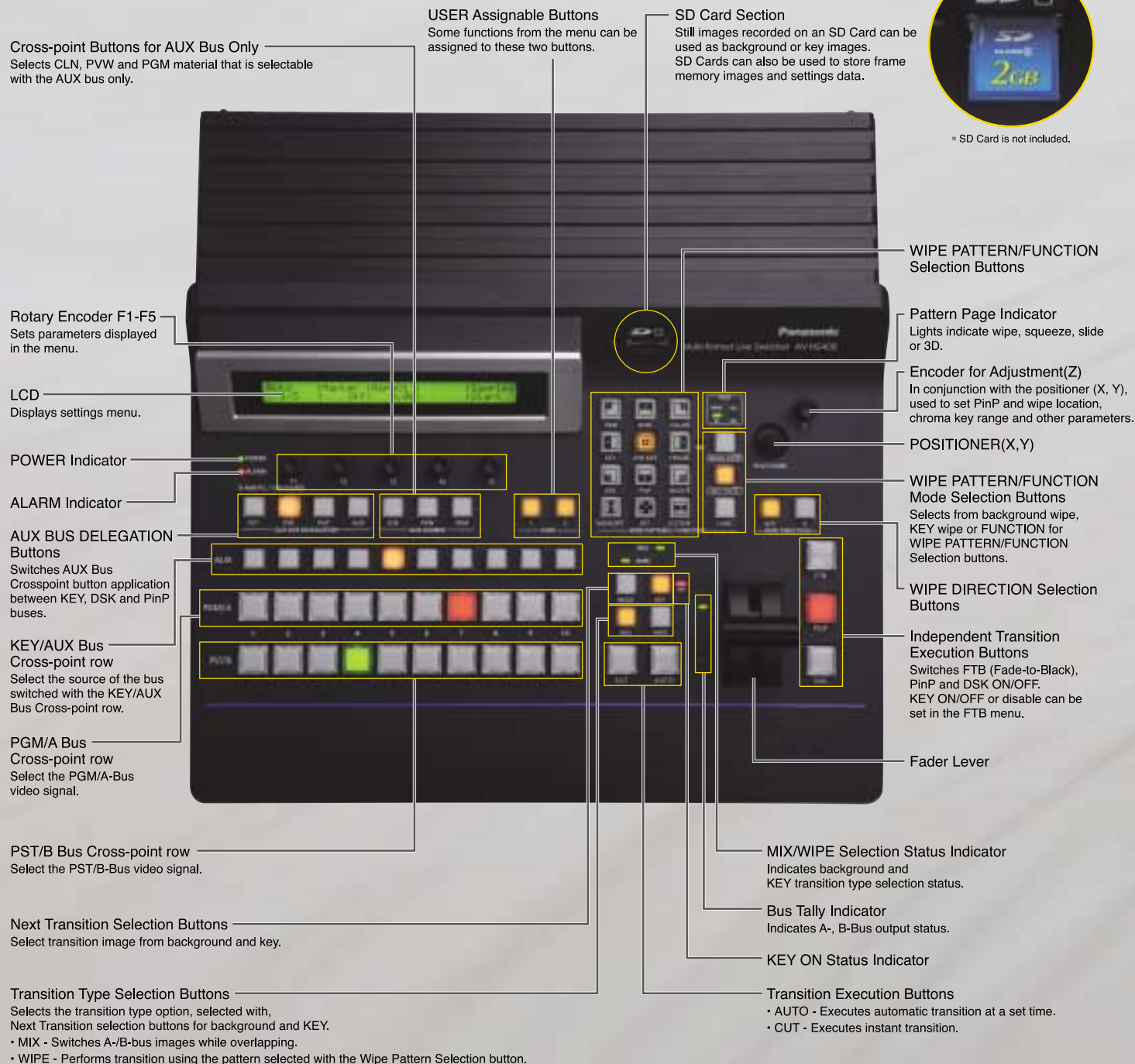

Example of an AV-HS400 monitor system

Simultaneous split-screen preview with a single monitor.



Example of conventional monitor system

Connection of separate monitors is required for each input, PVW and PGM.

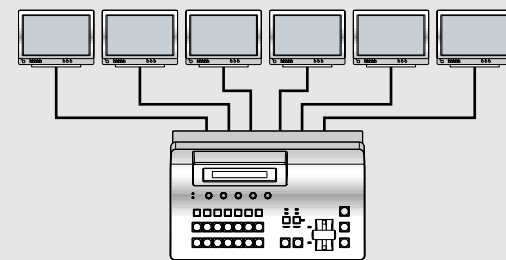

* The image shows loop-through outputs connected to switcher inputs.

■ Number and Location of Images is Selectable

- Display of signal name in each screen (ON/OFF possible).
- Display of red tally indications in frames for PGM output.
- Left/right switching of PGM and PVW screens possible.
- Arrangement of the images can be changed.



Ten Split Pictures (images)



Eight Split Pictures (images)



Four Split Pictures (images)

Multiple Effects for Stunning Results

In addition to standard wipe patterns, the DVE allows you to enjoy squeeze and slide effects, and different types of 3D. Luminance key, chroma key and DSK are also provided as standard. Plus PinP (Picture-in-Picture), with extremely simple operation.

A total of 43 effects offer great creative flexibility

WIPE

Switching between 12 wipe patterns.

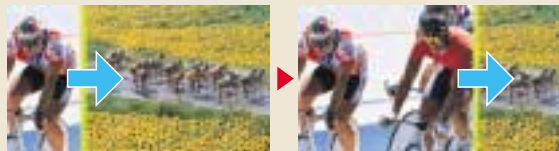

(images:pattern4)

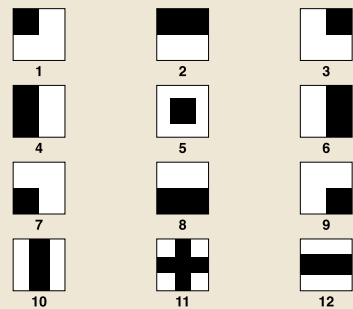

SL (Slide)

Switching between up, down, left, right and diagonal slide effects.



(images:pattern4)

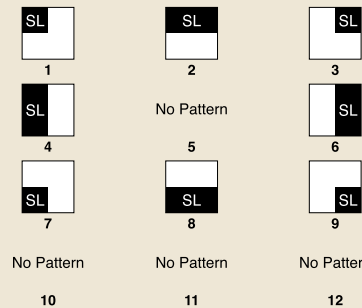

SQ (Squeeze)

Switching between 11 types of squeeze including center, top and bottom.

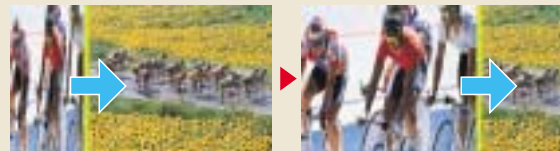

(images:pattern4)

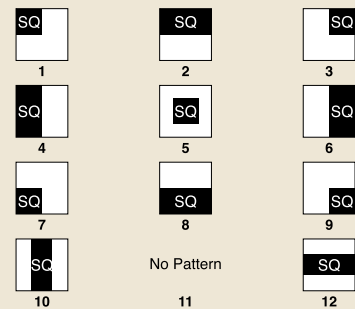

3D (3 Dimension)

Switching between 3D effects such as page turn and rotate.

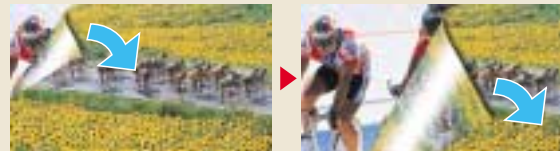

(images:pattern1)

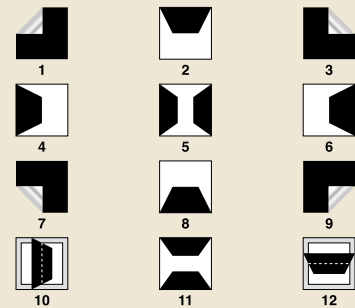

Chroma key for broadcast quality composite images

High-quality chroma key for broadcast and commercial production applications.

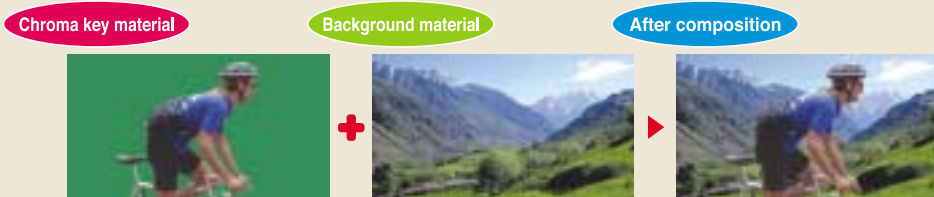

Example of composite effect

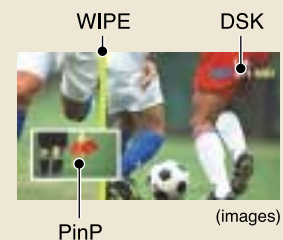

Ready for broadcast and studio production applications.

HD-SDI camera environment (with Genlock)

- ① SDI INPUTS(AV-HS04M1)
- ② SDI INPUTS(AV-HS04M1)
- ③ ANALOG OUTPUTS(AV-HS04M4)

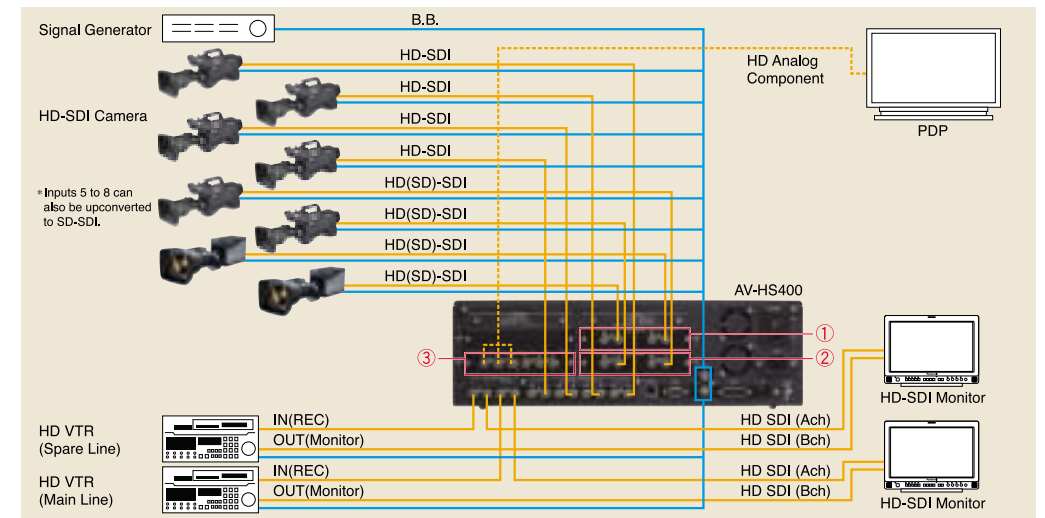

Ideal for use with simple systems at CATV stations, schools and other locations.

HD camera environment (no Genlock): Using the HD Analog component option

- ① DVI INPUTS(AV-HS04M3)
- ② ANALOG INPUTS(AV-HS04M2)
- ③ DVI/ANALOG OUTPUTS(AV-HS04M5)

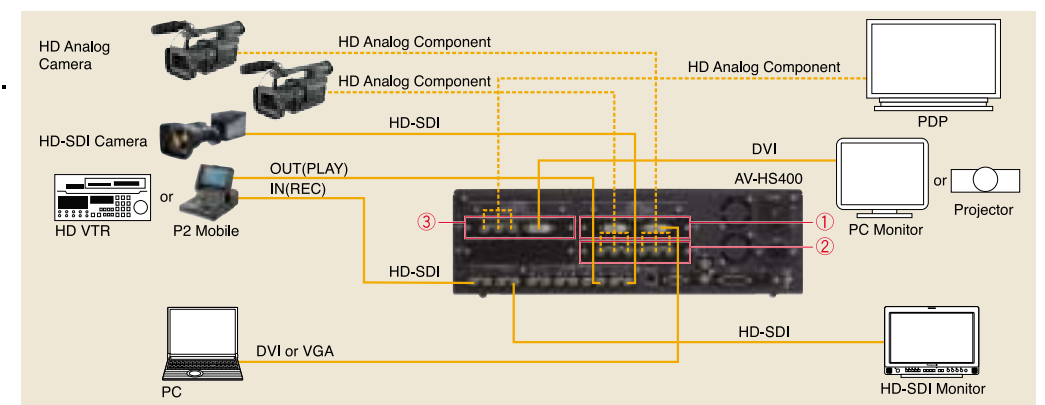

Provides the flexibility required for facilities moving from SD to HD production.

A combined HD/SD environment without Genlock.

- ① ANALOG INPUTS(AV-HS04M2)
- ② SDI INPUTS(AV-HS04M1)
- ③ DVI/ANALOG OUTPUTS(AV-HS04M5)
- ④ ANALOG OUTPUTS(AV-HS04M4)

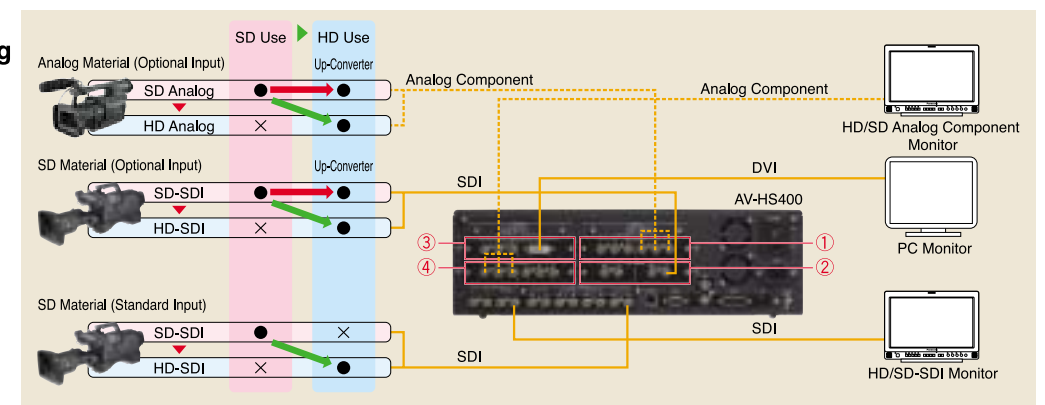

Option Boards You can expand inputs/outputs to match your system.

INPUTS

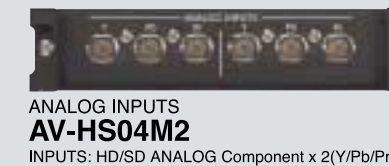

OUTPUTS

